

# 18LX60

LOW FREQUENCY



This 18" long excursion bass loudspeaker has been specifically designed to deliver high impact bass response, with exceptional high power handling capacity (600w RMS). It incorporates an edgewound ribbon voice coil (4" diameter) and vented magnetic structure. An optimum cooling system allows a fast heat exchange and contributes to the reduction of thermal power compression.

Modelo de 18" de gran desplazamiento para aplicaciones fundamentalmente de baja y muy baja frecuencia (subgraves). Este altavoz se caracteriza por una bobina de gran tamaño (4") con una potencia excepcionalmente alta (600 W RMS) debido a una estudiada refrigeración del bobinado, un excelente rendimiento y una reducida distorsión armónica.

### SPECIFICATIONS

Nominal diameter	460 mm. 18 in.
Rated impedance	8 ohms.
Power capacity*	600 w RMS
Program Power	1200 Watts.
Sensitivity	98 dB, 2.83v @ 1m @ 2π
Frequency range	25-1000 Hz
Recom. enclosure vol.	80-250 l 2.8/8.8 ft. <sup>3</sup>
Voice coil diameter	100 mm. 4 in.
Magnetic assembly weight	9 kg. 19.84 lb.
BL factor	20.5 N/A
Moving mass	0.172 kg.
Voice coil length	23 mm.
Air gap height	8 mm.
X damage (peak to peak)	40 mm.

PREDICTED LOW FREQUENCY RESPONSE • Bass-reflex cabinet, Vb=150,00 l, fb=30 Hz

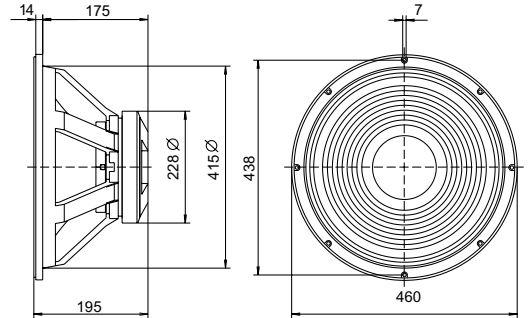
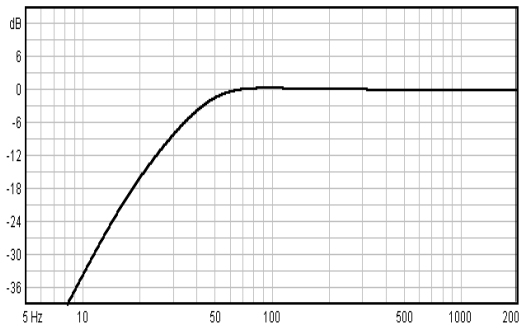

### MOUNTING INFORMATION

Overall diameter	460 mm. 18.11 in.
Bolt circle diameter	438 mm. 17.24 in.
Baffle cutout diameter:	
-Front mount	415 mm. 16.34 in.
-Rear mount	425 mm. 16.73 in.
Depth	195 mm. 7.67 in.
Volume displaced by driver	13 l 0.46 ft. <sup>3</sup>
Net weight	11.5 kg. 25.3 lb.
Shipping weight	13 kg. 28.6 lb.

FREQUENCY RESPONSE & DISTORTION CURVES, MAGN. On axis, 1w @ 1m.

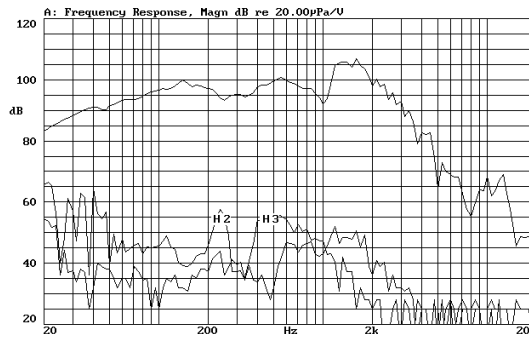

TIME RESPONSE, MAGN.

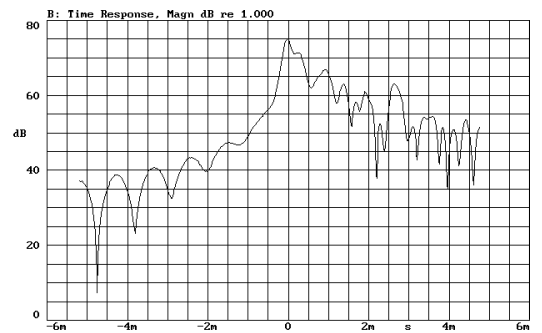

### MATERIALS

Basket	Cast aluminium
Cone	Paper
Surround	Treated cloth
Voice coil	Edgewound copper wire
Magnet	Ferrite

### THIELE-SMALL PARAMETERS\*\*

Resonant Frequency, fs	27 Hz
D.C. Voice Coil Resistance, Re	5.5 ohms.
Mechanical Quality Factor, Qms	11.45
Electrical Quality Factor, Qes	0.38
Total Quality Factor, Qts	0.37
Equivalent Air Volume to Cms, Vas	500 l
Mechanical Compliance, Cms	248 μm/N
Mechanical Resistance, Rms	2.2 kg/s
Efficiency, ηo (%)	2.5
Effective Surface Area, Sd(m <sup>2</sup> )	0.1320 m <sup>2</sup>
Maximum Displacement, Xmax	9 mm.
Displacement Volume, Vd	1200 cm. <sup>3</sup>
Voice Coil Inductance, Le @ 1kHz	1,2 mH

FREQUENCY RESPONSE, PHASE. On axis, 1w @ 1m.

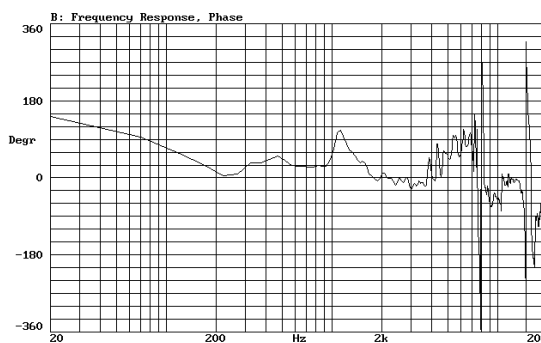

FREE AIR IMPEDANCE CURVE

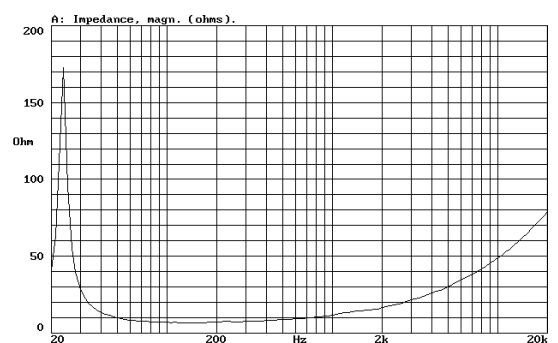

VOICE COIL INDUCTANCE CURVE

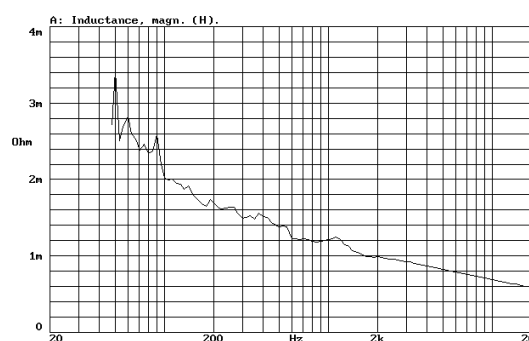

Re + Red(w) CURVE

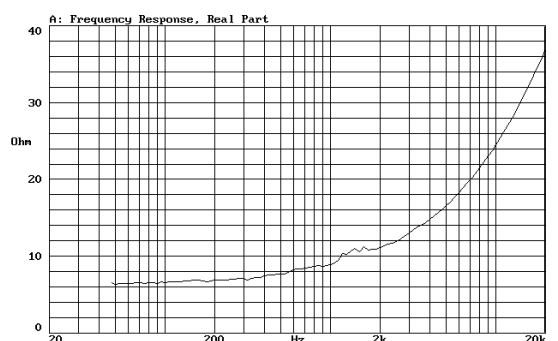

**NOTES**  
 \*The power capacity corresponds to the RMS maximum value that can dissipate the loudspeaker when a sinus signal is applied for a period of at least two hours.  
 Program power is defined as the transducer's ability to handle normal music program material.

\*\* T-S parameters are measured after an exercise period using a preconditioning power test, using a velocity-current laser transducer, and will reflect the long term parameters, once the loudspeaker has been working for a short period of time.

**NOTAS**  
 \*La potencia admisible corresponde a la máxima potencia RMS que puede disipar el altavoz durante al menos dos horas, cuando se le aplica una señal senoidal determinada.  
 Por potencia programa se entiende la capacidad del altavoz en el manejo de señales transitorias, como sería el proporcionado por el contenido de un pasaje musical normal.

\* Los parámetros T-S han sido medidos después de un periodo de fatiga y estabilización de las suspensiones, mediante transductor laser de velocidad-corriente, y son el reflejo de los parámetros a largo plazo del altavoz, una vez éste haya sido instalado y haya trabajado en un corto espacio de tiempo.